

正面姿図 S=1/30

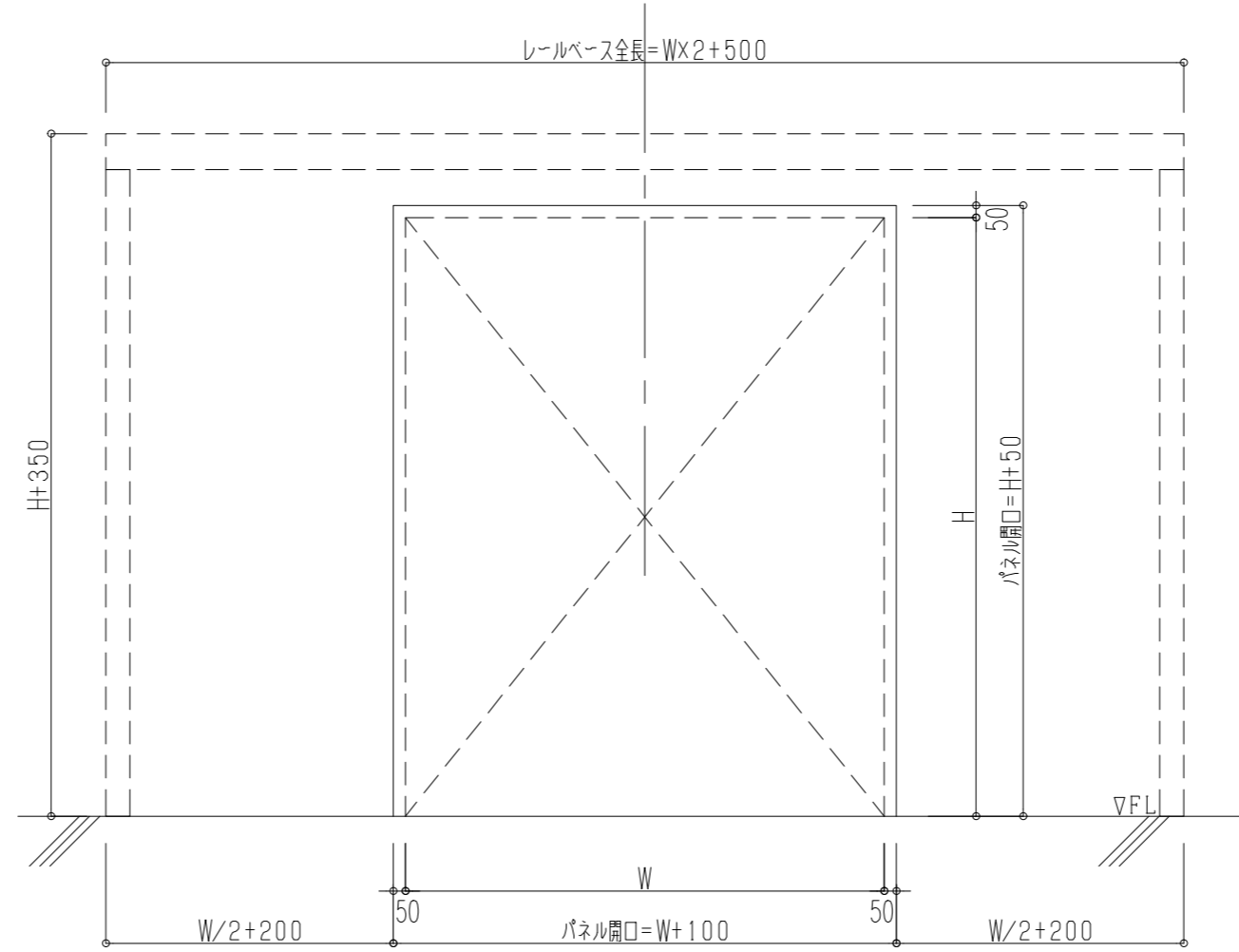

パネル開口図 S=1/30

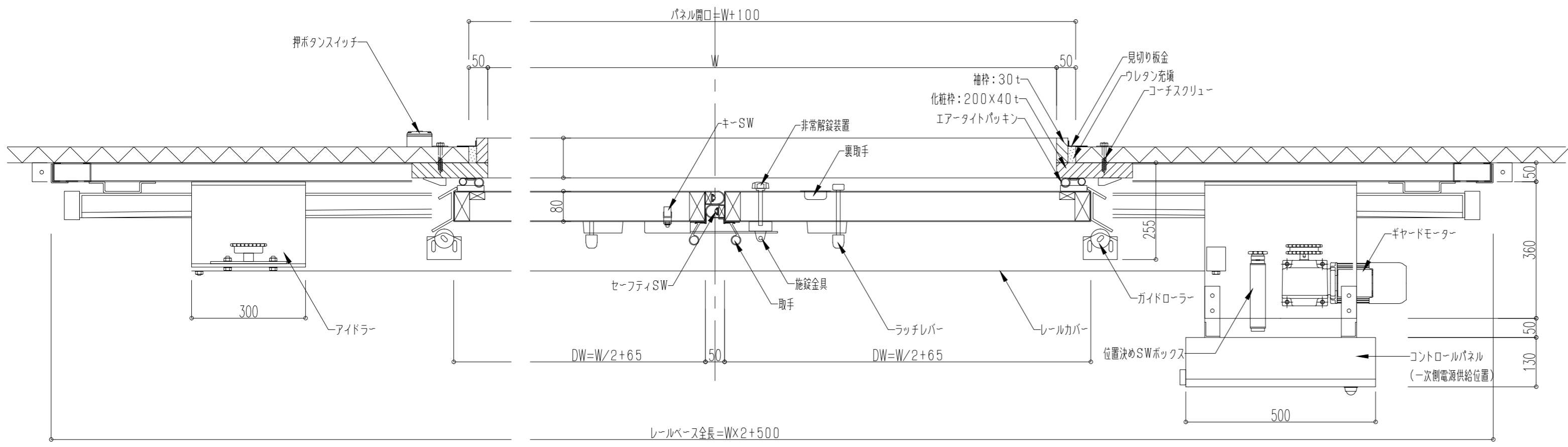

平面図 S=1/10

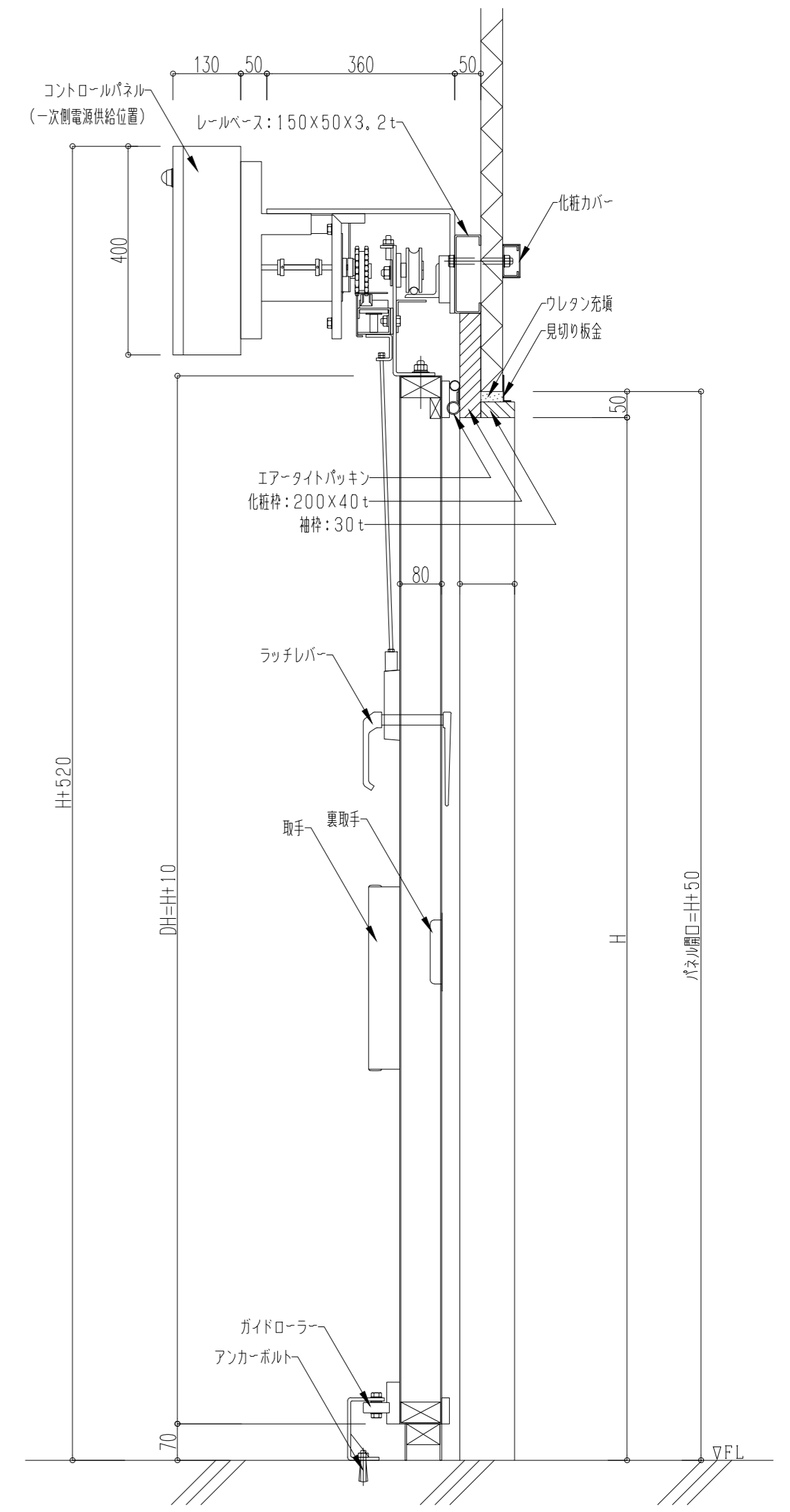

断面図 S=1/10

電動両引スライド扉(80t)